

lavanto® healthcare:

Medical Bowls made of Solid Surface Material.

Nemi.

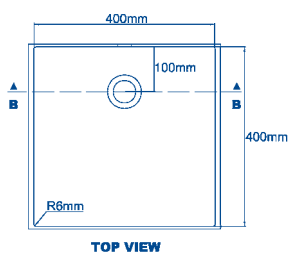

TOP VIEW

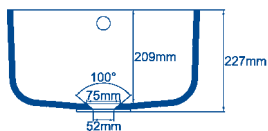

Section B - B

Albergo.

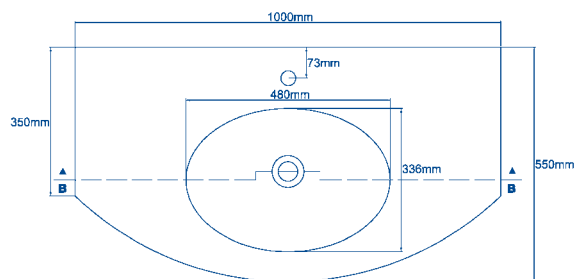

TOP VIEW

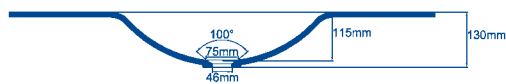

Section B - B

HI-MACS® 400-H

This bowl is available only in a limited colour range!

HI-MACS® 1000-H

This bowl is available only in a limited colour range!

Medico.

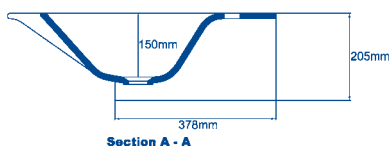
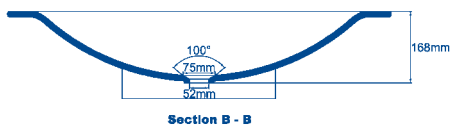
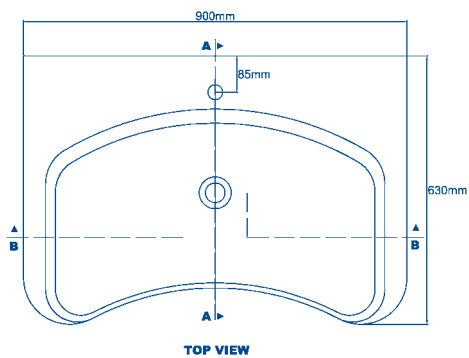

HI-MACS® 900-H

This bowl is available only in a limited colour range!

This bowl is also available in 900 x 542 mm without bore hole for tap.

Bracket

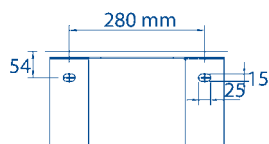

lavanto®healthcare:

Bowls Adapted for People with Disabilities made of Solid Surface Material.

Pennello A.

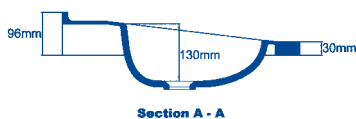
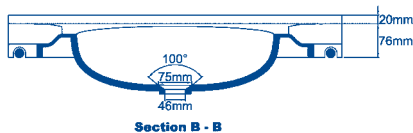
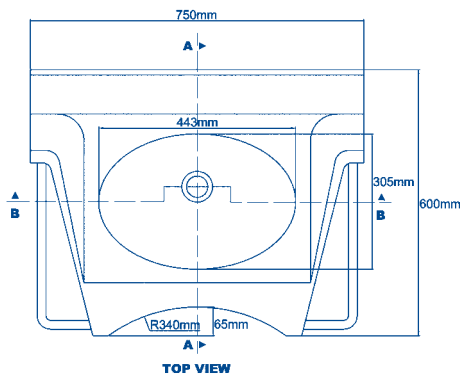

HI-MACS® 750P-H

This bowl is available only in S28 Alpine White.

Pennello B.

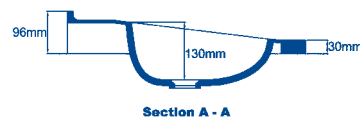
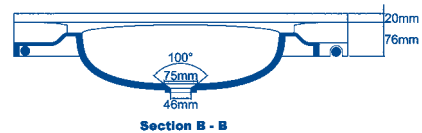
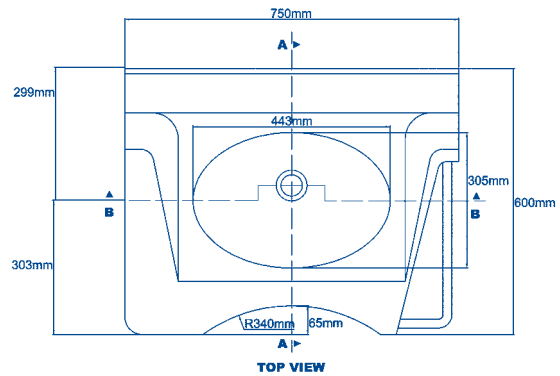

Handle on the right

HI-MACS® 750PR-H

Handle on the left

HI-MACS® 750PL-H

This bowl is available only in S28 Alpine White.

The bowl can be manufactured with a multifunctional handle on either the left or the right side.

The Pennello bowls from the **lavanto®healthcare** series are adapted for people with disabilities and meet all requirements of people with physical disabilities in hospitals, in nursing homes and private living environments. The concave shape perfectly fits the body and allows both sitting and standing positions during daily personal hygiene. The affixed top-quality stainless steel multifunctional handle can be used for holding up, pulling up or as a towel holder. The Pennello bowls have no joints, edges or corners. That makes cleaning easier while satisfying all hygienic requirements.

lavanto® healthcare:

Medical Bathtubs made of Solid Surface Material.

Bambino A.

Bambino B.

Bambino C.

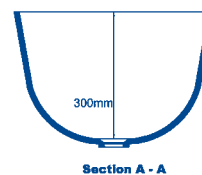
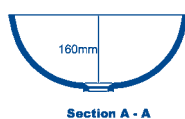
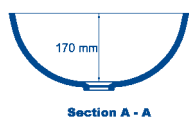
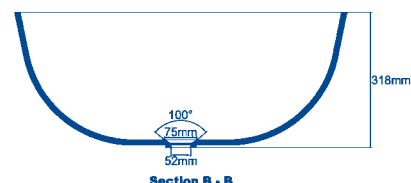
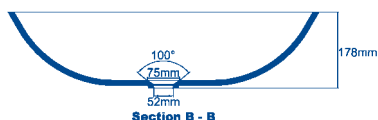
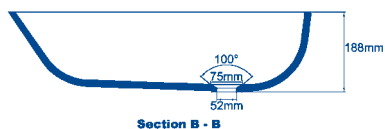
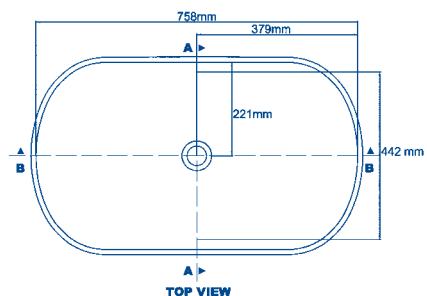
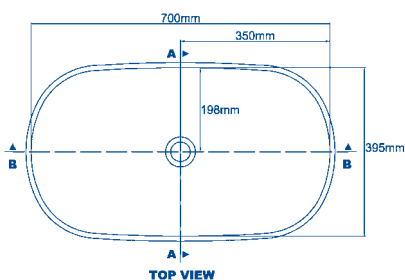
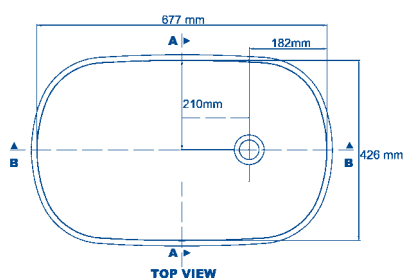

HI-MACS® 677-H

HI-MACS® 700-H

HI-MACS® 758-H

This tub is available only in a limited colour range!

This tub is available only in a limited colour range!

This tub is available only in a limited colour range!

Bambino bathtubs by Rosskopf & Partner are high-grade bathtubs made of solid surface material that optimally meet the high requirements of infant medicine and nursing.

R+P
ROSSKOPF UND PARTNER



lavanto® (product and registered trademark of Rosskopf & Partner)
HI-MACS® (product and registered trademark of LG)